

FTS250-LP GPS Disciplined Oscillator



2111 Comprehensive Drive
Aurora, Illinois 60505
Phone: 630-851-4722
Fax: 630-851-5040
www.conwin.com

D
A
T
A
S
H
E
E
T

Connor-Winfield's GPS Disciplined Oscillators (GPSDOs) were created specifically for precision timing, synchronization and time stamping applications requiring high end, cost sensitive solutions. By combining our uniquely designed phase lock loop circuitry, a GPS/GNSS receiver and our high-quality oscillators, Connor Winfield is able to offer a wide variety of superior, cost-effective GPS timing solutions. The FTS250 Series modules provide customer applications with the precise timing capabilities needed to optimize critical system performance.

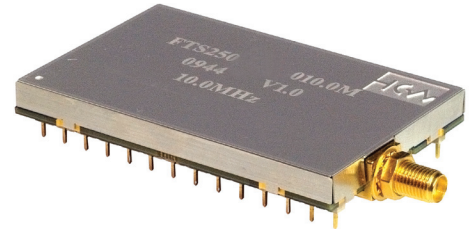

General Description

The FTS250-LP-010.0M Frequency and Time Standard module is a GPS/GNSS disciplined oscillator providing a 1 PPS CMOS output from an onboard GPS/GNSS timing receiver. The FTS250-LP generates two clock outputs, a 10 MHz CMOS and a 10 MHz SINE output generated from an intrinsically low jitter voltage/temperature controlled crystal oscillator. The FTS250-LP steers the 10MHz output from the 1 PPS reference derived from the on-board GPS/GNSS receiver. Two separate power pins allow for a low power holdover capability when the GPS/GNSS receiver is shut down. In low power mode, the VCTCXO maintains its last locked frequency accuracy and relies upon the thermal stability of the VCTCXO for holdover performance of the two clock outputs. Multiple thermal stability options are available.

Alarms are provided to indicate Loss-of-Lock, Holdover, and Antenna Fault status. The on-board GPS receiver requires an outdoor mounted GPS/GNSS antenna for the best stability and consistent performance. The mode control inputs are used to manually switch between the GPS/GNSS references and holdover. The user application should monitor the alarm outputs and manually switch modes as needed.

Serial I/O lines provide access to the NMEA messages from the GPS receiver. The serial I/O lines can be used to access GPS timestamp information, or to verify that the receiver has recovered from an alarm condition. The reset is used to reset the GPS receiver (if needed).

Features

- Phase locked 10 MHz output (other frequencies available upon request)
- Phase locked 1 PPS output
- Three selectable references: GPS, External 10 MHz or External 1 PPS
- Low Power Holdover mode capability
- Three alarm outputs. (Loss-of-Lock, Holdover and Antenna Fault)
- Serial input and output ports (GPS receiver)
- Master reset
- +3.3 Volt power supply
- Temperature Range: -40°C to 85°C
- Meets ITU-T G.811 Wander Generation Mask
- SMA Bulkhead GPS Antenna Connection
- Package: 28-pin Through-Hole
- Physical Dimensions: 2.8" x 1.725" x 0.368" (71mm x 43.82mm x 9.34mm)
- Fixed Position
- Multiple Output Frequency Options in addition to 10MHz.

Bulletin	SG208
Revision	01
Date	18 Feb 2022

Functional Block Diagram

Figure 1

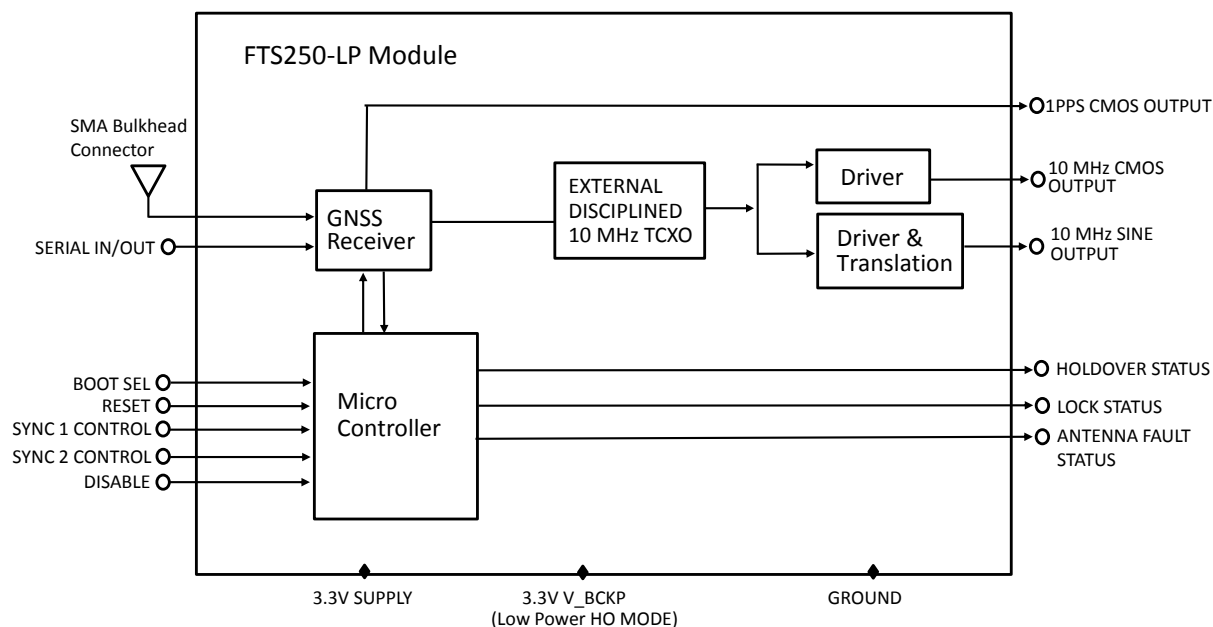

Pin Description

Table 1

Pin #	Pin Name	Description	Note
1	Vcc2	3.3V \pm 5% Supply Voltage	
2	GND		
3	*Reset	Hardware Reset for GPS Circuitry. Pull low to Reset	1
4	*Disable	Open/High = Enabled Outputs. Low = Disabled Outputs	1
5	1 PPS Ref Input	External 1 PPS reference	1
6	GND		
7	10 MHz Ref Input	External LVCMOS 10 MHz Reference	1
8	NU	Used for Factory Programming	
9	NU	Used for Factory Programming	
10	NU	Used for Factory Programming	
11	NU	Used for Factory Programming	
12	*Bootssel	Normally High - Pulled low during Wi125 software updates	
13	GND		
14	Vcc1	3.3V \pm 5% Supply Voltage	2
15	Antenna Supply Voltage	2.7 to 13.2V Input Supply Voltage for the Antenna. Max 45mA continuous current	
16	GND		
17	RXA	RS-232 Communication receive signal for UART-0	
18	TXA	RS-232 Communication transmit signal for UART-0	
19	SYNC2 Control	Lock mode selection control signal 2	1
20	SYNC1 Control	Lock mode selection control signal 1	1
21	Lock Status	High = Unit is locked to the selected reference	1
22	Holdover Status	High = Unit is in Holdover	1
23	Antenna Fault Status	High = Fault detected on the Antenna Supply Voltage (Self Clearing)	1
24	1 PPS CMOS Output	1 PPS LVCMOS Output	1
25	GND		
26	10 MHz CMOS Output	10 MHz LVCMOS Output (Default)	1, 3
27	GND		
28	10 MHz SINE Output	10 MHz Sine Output (\sim 9dBm)	

Note: 1. 3.3 VDC (LVCMOS) compatible
 2. If OCXO option is chosen, must add OCXO current to this base current.

Absolute Maximum Rating

Table 2

Symbol	Parameter	Minimum	Maximum	Units	Notes
V _{CC}	Power Supply Voltage	-0.3	3.7	Volts	1
V _{IN}	Input Voltage	-0.3	4.6	Volts	1
V _{PREAMP}	Antenna Supply Voltage	2.7	13.2	Volts	1
T _S	Storage Temperature	-40	85	°C	1

Operating Specifications

Table 3

Symbol	Parameter	Minimum	Nominal	Maximum	Units	Notes
V _{CC1}	Supply Voltage 1	3.135	3.3	3.465	V	2
I _{CC1}	Supply Current 1		0.270		A	
V _{CC2}	Supply Voltage 2	3.135	3.3	3.465	V	2
I _{CC2}	Supply Current 2		0.036		A	
T _O	Temperature Range	-40		85	°C	
t _{JTOL}	Input Jitter Tolerance	30			ns	
t _{AQ_GPS}	GPS Input Acquisition Time		100		sec	3
t _{AQ_EXT}	External Input Acquisition Time		100		sec	3

Oscillator Performance

F _{CAP}	Capture/Pull-in Range	Dependent upon holdover option chosen			ppm
F _{BW}	Jitter Filter Bandwidth	0.8			Hz
DC	Duty Cycle	45/55			%
RMS	RMS Phase Noise	10 Hz - 2 MHz			ps
		12 kHz - 2 MHz			
		1.2			
		0.6			

Holdover/Wander Generation Performance

					4	
	Frequency Stability	See Holdover Specification Options			ppm	5
	Wander Generation Specification	ITU-T G.811				

NOTES:

1. Stresses beyond those listed under "Absolute Maximum Rating" may cause permanent damage to the module. These are stress ratings only and functional operation of the device at these or any other conditions beyond those indicated under "Operating Specifications" is not implied. Exposure to absolute maximum rated conditions for extended periods may affect device reliability.
2. Requires external regulation and supply decoupling.
3. Cold Power-up.
4. Holdover will be re-calculated with each successful lock. Yearly aging represents 1 continuous year in Holdover.
5. Includes unidirectional temperature stability, Vcc stability, and 24 hours of aging.

Mode Control Table

Table 4

SYNC 1	SYNC 2	Operating Mode
0	0	Force Holdover
0	1	Lock to External 10 MHz reference*
1	0	Lock to External 1 PPS reference
1	1	(Default) Lock to GPS Signal

* Note: Holdover is not supported in this mode; loss of the 10MHz reference will rail the PLL output until the reference returns or another mode is selected.

Input And Output Characteristics

Table 5

LVCMOS Inputs and Outputs

Symbol	Parameter	Minimum	Maximum	Units	Notes
V _{IH}	High Level Input Voltage	1.7	4.0	V	
V _{IL}	Low Level Input Voltage	-0.5	0.8	V	
V _{OH}	High Level Output Voltage	2.4		V	
V _{OL}	Low Level Output Voltage		0.4	V	
C _O	Output Capacitance		10	pF	

10 MHz Sine Output

Symbol	Parameter	Typical	Units	Notes
	Load	50	ohms	
	Output Power	9	dB _m	
	Total Harmonic Distortion	2.2	%	

GPS Receiver Specifications

Table 6

Parameter	Specifications	Notes
Time to First Fix:	Cold: 29 sec Aided Cold Start <2 sec Timing Fix: Additional 15 sec	
Sensitivity	Acquisition/Tracking -165dBm Aided Acquisition -157dBm Re-acquisition -160dBm Cold Start -148dBm	
Supported Protocols	Network Assist, NMEA 0183	

Reset Generation (I/O pin 3 - RESET)

The power-on-reset for the FTS250-LP is generated on-board. If it is desired to extend the power-on-reset signal or provide a manual reset of the GPS receiver, pull this signal low.

Antenna Requirements

Table 7

Parameter	Notes
The FTS250-LP antenna connector is a SMA Bulkhead (female)	
The antenna supply voltage provided to Pin 15 must be within the range of 2.7 to 13.2V (AMR); the antenna must be able to operate at this voltage	
The antenna's continuous current draw must be $\leq 45\text{mA}$	
The antenna must have a full sky view for optimal receiver performance	
An active antenna with a minimum 10dB gain (including cable loss) should be used	

Phase Noise

Figure 2

Phase Noise:	
Offset Frequency (Hz)	(dBc/Hz)
10	-90 (Typ)
100	-125 (Typ)
1k	-138 (Typ)
10k	-142 (Typ)
100k	-150 (Typ)
1M	-152 (Typ)

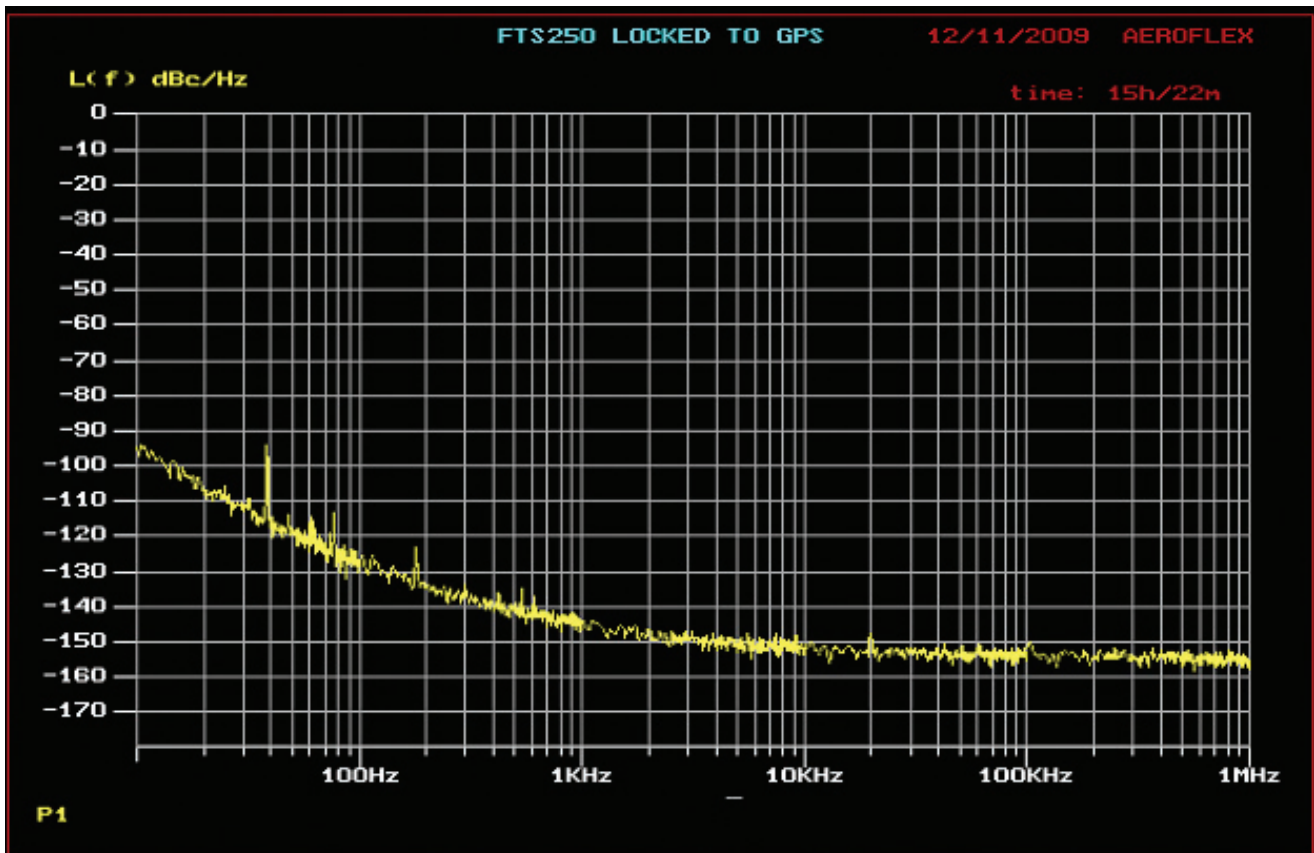

Allan Variance
Figure 3

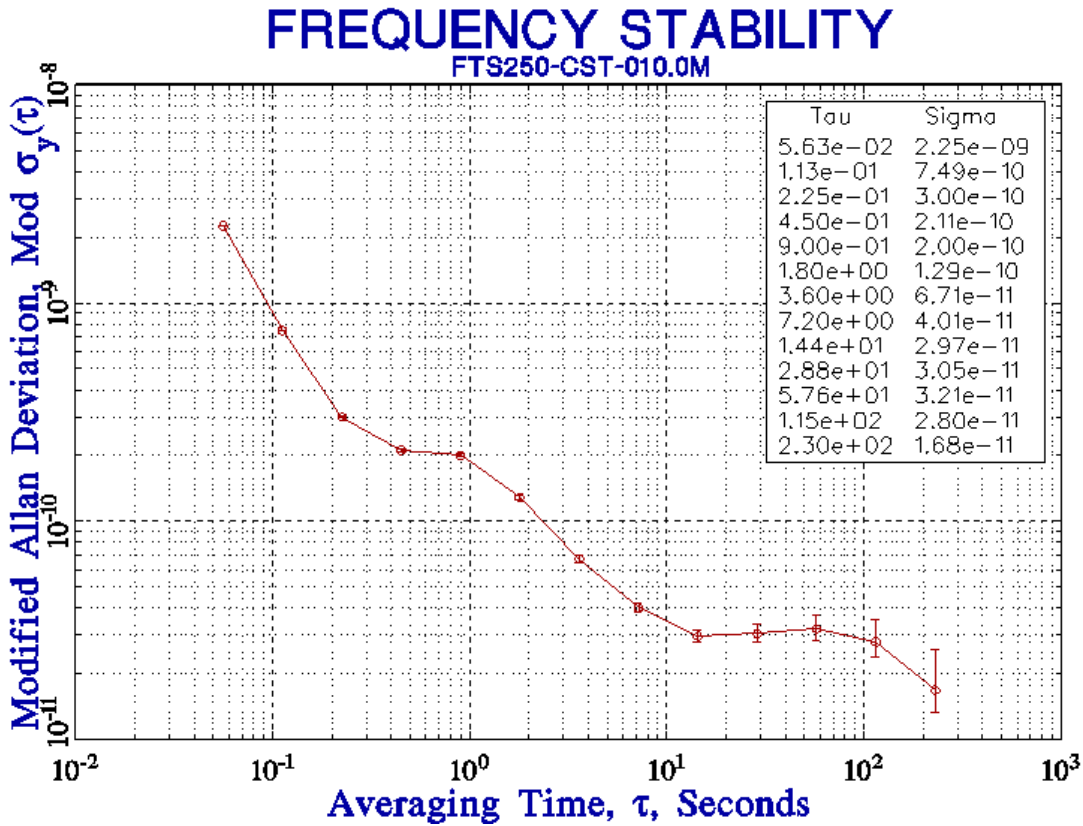

Wander Generation Plot – FTS250-LP versus G.811 Wander Generation Mask
Figure 4

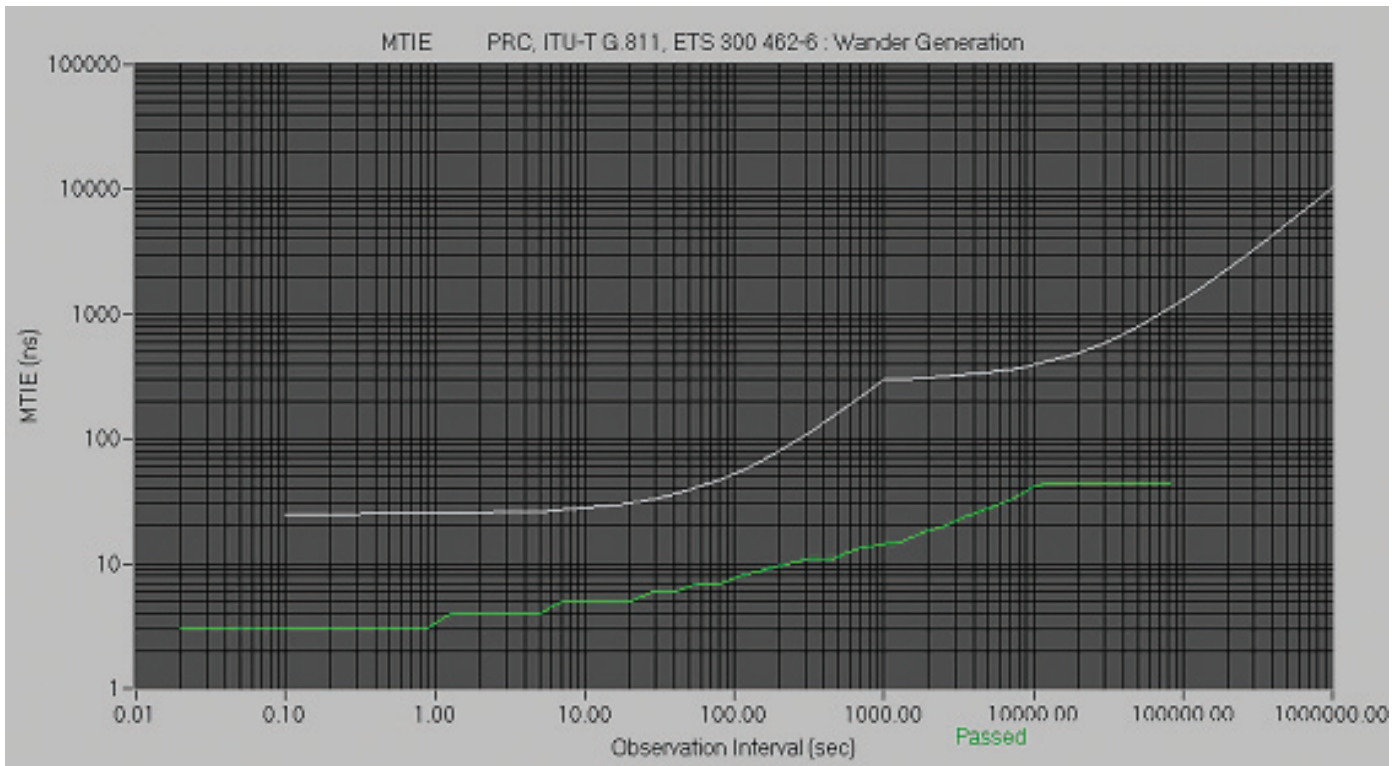

Soldering and Cleaning Recommendations

Hand solder, leaded wave solder, and lead-free wave solder processes are recommended for attaching the FTS250-LP after reflow processes are complete. Since the FTS250-LP does not have hermetic enclosure, hand cleaning the leads is recommended and the module should not be completely immersed.

Package Dimensions

Figure 5

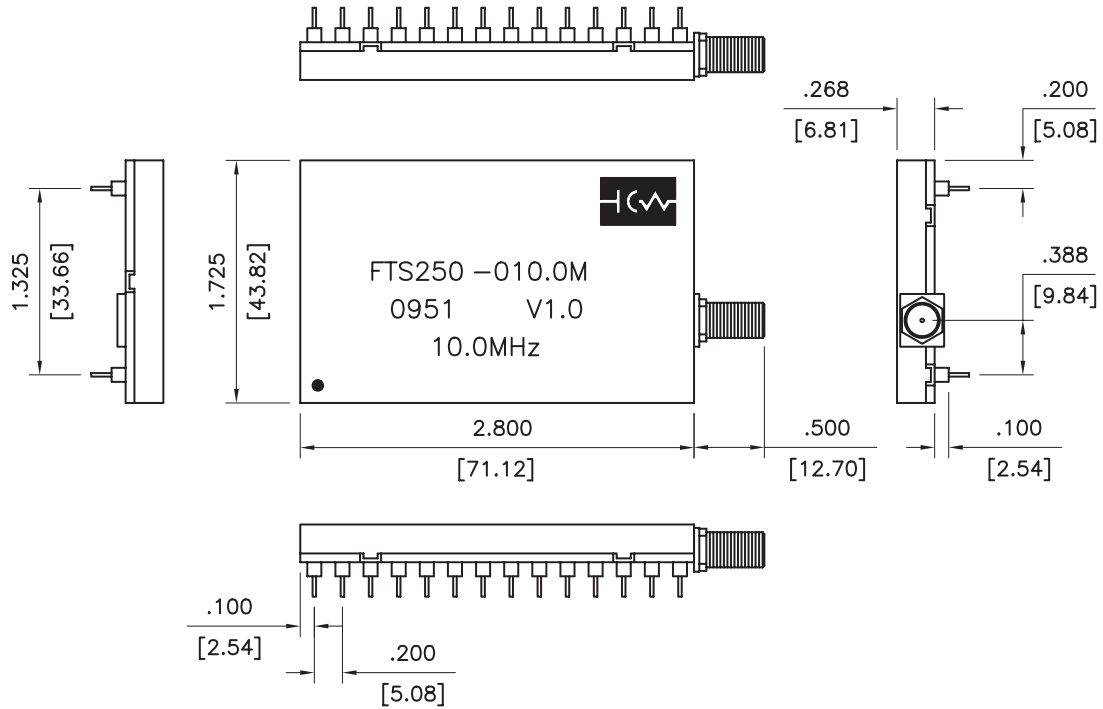

Top View Dimensions & Keep-out Area

Figure 6

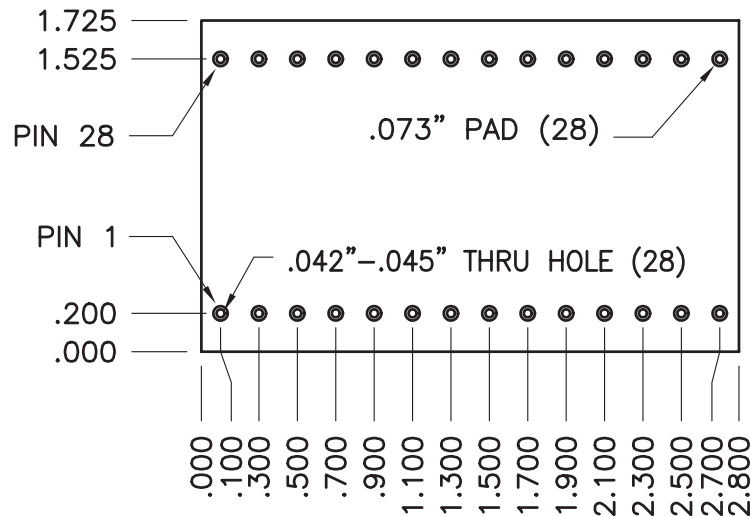

FTS250-LP GPS Disciplined Oscillator

Available at Digi-Key
www.digikey.com

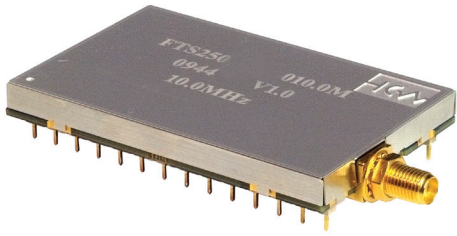

2111 Comprehensive Drive
Aurora, Illinois 60505
Phone: 630-851-4722
Fax: 630-851-5040
www.conwin.com

Ordering Information

FTS250-LP -T1 -010.0M*

Holdover Specification Options based on a choice of VCTCXO model number used on module Thermal Stability Options:

-T1: T200V:	±200ppb	-40 to 85°C	(http://www.conwin.com/datasheets/tx/tx350.pdf)
-T2: T100V:	±100ppb	0 to 70°C	(http://www.conwin.com/datasheets/tx/tx350.pdf)
-T3: TL604:	±100ppb	-20 to 70°C	(http://www.conwin.com/datasheets/tx/tx414.pdf)
-T4: T604:	±280ppb	-40 to 85°C	(http://www.conwin.com/datasheets/tx/tx176.pdf)
-T5: T614:	±0.5ppm	-40 to 85°C	(http://www.conwin.com/datasheets/tx/tx176.pdf)

Revision	Date	Note
00	02/16/22	Release
01	02/18/22	Update TCXO part numbers to VCTCXO versions